

PROTEZIONE
PROTECTION
IP66

IMPATTO
IMPACT
IK10/8

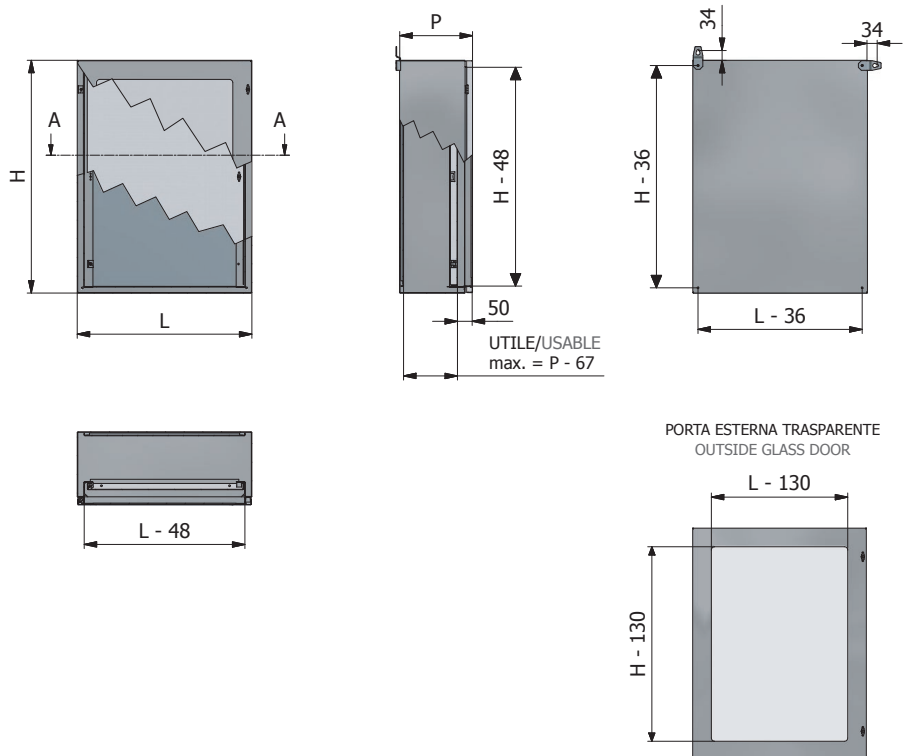

**SISTEMI DI AERAZIONE
VENTILATION SYSTEMS** **PAG. 145**



Composta da corpo, porta esterna trasparente, porta interna, piastra interna fissata sul fondo.

Composed of cabinet structure, outside glass door, internal door, inside mounting plate fixed on the back.



ACCESSORI A RICHIESTA (RICAMBIO)
ACCESSORIES ON DEMAND (REPLACEMENT)

Dimensioni Dimensions	Articolo Article	N. serrature No. of hinges	PIASTRA INTERNA MOUNTING PLATE				PORTA INTERNA INSIDE DOOR			
			H	H	L	W	H	H	L	W
NEW ▶ 400	300	160	PDXT4.30.16	1	350	250	PI4.30	347	337	IX4.30
NEW ▶ 400	300	200	PDXT4.30.20	1	350	250	PI4.30	347	337	IX4.30
500	350	160	PDXT5.35.16	2	450	300	PI5.35	447	287	IX5.35
500	350	200	PDXT5.35.20	2	450	300	PI5.35	447	287	IX5.35
NEW ▶ 500	350	300	PDXT5.35.30	2	450	300	PI5.35	447	287	IX5.35
600	400	200	PDXT6.40.20	2	550	350	PI6.40	547	337	IX6.40
600	400	250	PDXT6.40.25	2	550	350	PI6.40	547	337	IX6.40
700	500	200	PDXT7.50.20	2	650	450	PI7.50	647	437	IX7.50
700	500	250	PDXT7.50.25	2	650	450	PI7.50	647	437	IX7.50
800	600	250	PDXT8.60.25	2	750	550	PI8.60	747	537	IX8.60
900	600	250	PDXT9.60.25	2	850	550	PI9.60	847	537	IX9.60
900	600	300	PDXT9.60.30	2	850	550	PI9.60	847	537	IX9.60
NEW ▶ 1000	800	300	PDXT10.80.30	2	950	750	PI10.80	947	737	IX10.80
1100	700	250	PDXT11.70.25	2	1050	650	PI11.70	1047	637	IX11.70

PIASTRINE DI FISSAGGIO INOX

Composto da: quattro piastrine di fissaggio INOX e viteria.

MOUNTING BRACKETS MADE OF STAINLESS STEEL

The supply includes: four wall mounting brackets and screw.

Articolo
Article

QX104



STAFFE INOX PER

APPLICAZIONE LUCCHETTO

STAINLESS STEEL BRACKET TO APPLY
PADLOCK

Articolo
Article

SL10

PIANO INCLINATO PER COLONNA CLX1000

Piano in inox.

TITLED PLAN FOR COLUMN CLX1000

Manufactured stainless steel.

Articolo
Article

ICX20

Inclinato a 20° inox



COLONNA PER CASSETTE SERIE PDX, PDXT
Piastra di fissaggio al pavimento sp. 6 mm
colonna in AISI 304 con pannello anteriore
asportabile.

COLUMN FOR PDX, PDXT BOXES

Plate for floor fixing made of AISI 304 6 mm
column manufactured in stainless steel
with front panel.

Articolo
Article

CLX1000

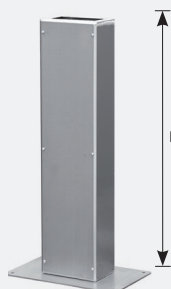

BASE APOGGIO PER CASSETTA SERIE PDX SU COLONNA CLX 1000

SUPPORT BASE FOR PDX BOXES ON TOP
OF THE COLUMN CLX1000

Larghezza
cassetta
Width box

L | W

NEW ▶

500

Articolo
Article

BAX5020

NEW ▶

600

BAX6020

PDX
INOX
STAINLESS STEEL



GRIGLIE CON FILTRO IP54

- Griglia in ABS autoestinguente UL94 VO con filtro EU3;
- Viti di fissaggio e guarnizione adesiva;
- Confezione singola in scatola di cartone;
- Colore RAL7035;
- Certificati UL.

FILTER UNITS IP54

- Grille made of self-extinguishing ABS UL94V0 with EU3 filter;
- Affixed by four self-threading screws;
- Single packet in carton box;
- Painted RAL7035;
- Certified UL.

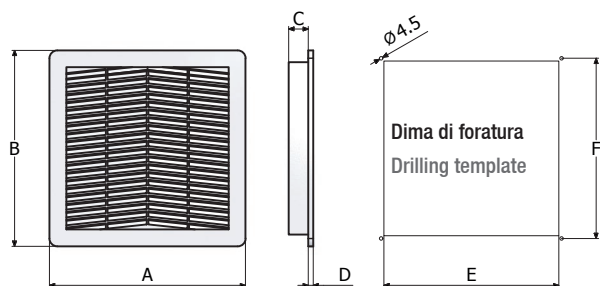

Articolo Article	A	B	C	D	E	F
FIL00	105	105	14	7	92	95
FIL10	150	150	21	7	125	131
FIL20	250	250	23	8	223	230
FIL30	325	325	24	9	291	302



GRIGLIE CON VENTILATORE IP54

- Griglia in ABS autoestinguente UL94VO con filtro EU4, contenitore ventilatore in ABS con griglia di protezione, ventilatore, morsettiera, guarnizione adesiva e viti di fissaggio;
- Confezione singola in scatola di cartone;
- Colore RAL7035.

FAN AND FILTER IP54

- Grille made of self-extinguishing ABS UL94V0 with EU4 filter fan with motor protection, gasket, self-threading screws and terminals;
- Single packet in carton box;
- Painted RAL7035.

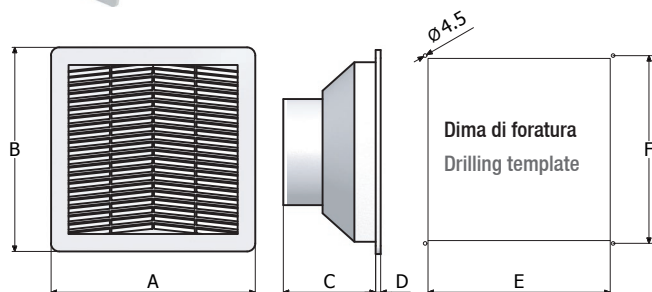

Articolo Article	A	B	C	D	E	F
VEN10 (UL)	150	150	64	7	125	131
VEN20	250	250	113	8	223	230
VEN20UL	250	250	113	8	223	230
VEN30	325	325	152	9	291	302
VEN30UL	325	325	152	9	291	302
VEN910 (UL)	150	150	64	7	125	131
VEN920	250	250	113	8	223	230

Articolo Article	Tensione Power supply	Frequenza Frequency	Assorbimento Absorption	Portata aria kit Air flow set	Rumore Noise	Temp. di esercizio Rated temp. range	
	V	Hz	mA	W	dB (A)	°C	
VEN10 (UL)	230c.a.	50/60	125/110	20/19	57/61	43/48	-10/+55
VEN20 / VEN20UL	230c.a.	50/60	120/120	29/30	240/270	50/55	-10/+55
VEN30 / VEN30UL	230c.a.	50/60	300/370	59/72	520/580	63/65	-10/+55
VEN910 (UL)	115c.a.	50/60	210/180	20/18	57/61	43/48	-10/+55
VEN920	115c.a.	50/60	250/260	29/30	240/270	50/55	-10/+55

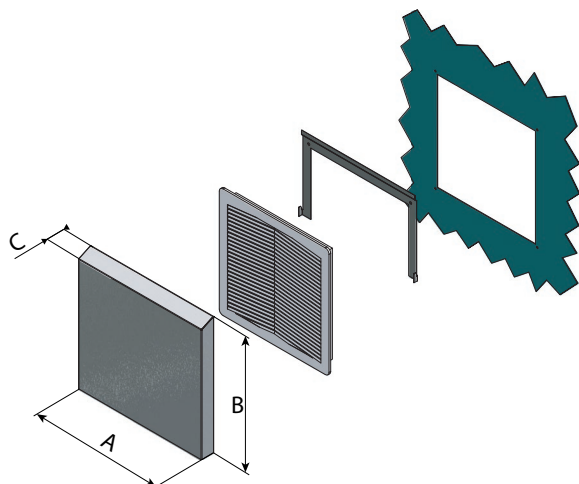

CUFFIA DI PROTEZIONE INOX

Cuffia inox AISI304 di protezione per filtri e ventilatori.

STAINLESS STEEL PROTECTION FOR FAN AND FILTER

Protection for fan and filter made in AISI304 stainless steel.

Articolo Article	Compatibili con Compatible with			A	B	C
	FIL	VEN				
RDP10	FIL10	VEN10		188	176	40
RDP20	FIL20	VEN20		288	276	40
RDP30	FIL30	VEN30		367	350	40

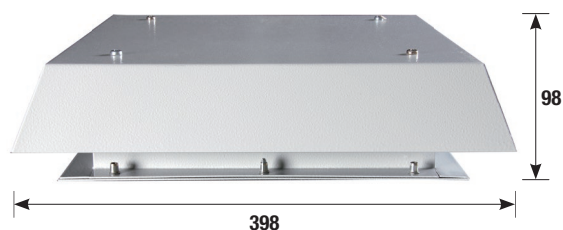

TORRINO DI ESTRAZIONE MONOFASE

- Grado di protezione: IP 23;
- Composizione: tetto, corpo supporto ventilatore, ventilatore radiale, supporto raccordo di aspirazione con salvadita, condensatore e morsetteria, guarnizione ed accessori per il montaggio;
- Verniciatura: a polveri termoindurenti RAL7035.

SINGLE PHASE EXTRACTING POWER

- Protection degree: IP 23;
- Composed of: roof, ventilator support, radial ventilator, connector for aspiration with saver finger, terminal and condenser, gasket and mounting accessories;
- Painted: RAL7035.

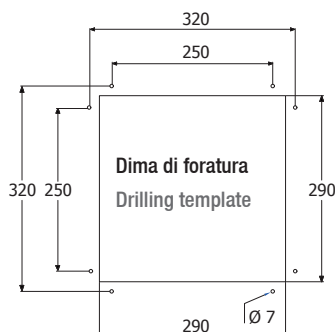

Articolo Article	Alimentazione Voltage	Frequenza Frequency	Assorbimento Absorption	Portata aria Air flow		Rumore Noise	Temp. max Max temp.
	VAC	Hz	A	W	m ³ /h	dB (A)	°C
TV600	220/240	50/60	0,29	65	600	61	60
TV610	115	50/60	0,58	55/69	590/610	58/60	60
TV940	220/240	50/60	0,41	91	940	68	60



TORRINO DI AERAZIONE

- Grado di protezione: IP 23;
- Verniciatura: a polveri termoindurenti RAL7035.

AERATION VENTILATOR CHIMNEY

- Protection degree: IP23;
- Painted: RAL7035.

Articolo Article	
TV010	



TORRINO DI ESTRAZIONE MONOFASE

- Costruzione: struttura in plastica, coperchio inox;
- Verniciatura: RAL7035;
- Grado di protezione: IP54.

SINGLE PHASE EXTRACTING POWER

- Structure: plastic structure, stainless steel roof;
- Painted: RAL7035;
- Protection degree: IP54.

Articolo Article	Alimentazione Voltage	Frequenza Frequency	Assorbimento Absorption	Portata aria Air flow	Rumore Noise	Temp. max Max temp.
	VAC	Hz	A	W	m ³ /h	dB (A)
TV530	230	50/60	0,71	78/82	530/563	59/61
						°C

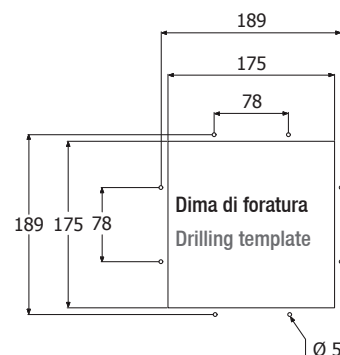

TORRINO DI AERAZIONE SENZA MOTORE

Grado di protezione: IP 54 verniciatura: a polveri termoindurenti RAL7035.

AERATION VENTILATOR CHIMNEY WITHOUT ENGINE

Protection degree: IP54 painted: RAL7035.

Articolo
Article

TV020

TERMOSTATI

THERMOSTATS



1

2

3

Articolo Article	Descrizione Description
1 TE10	10A 230V NC -10° +60°
2 TE20	10A 230V NO -10° +60°
3 TE30	10A 230V NO/NC -10° +65°

KIT SUPPORTO REGOLABILE PER PROFILO DIN (2+2 PEZZI)

ADJUSTABLE SUPPORT KIT FOR DIN PROFILE (2+2 PIECES)

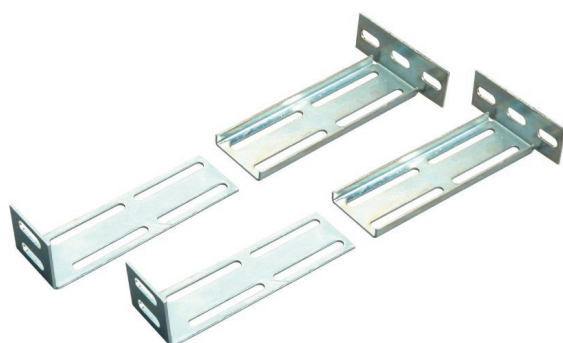

Articolo Article	Descrizione Description
SU450D	Coppia di supporti profilo DIN H=150 completo di viti Couple supports for DIN profile H=150 with bolts