

PROTEZIONE  
PROTECTION  
**IP66**

IMPATTO  
IMPACT  
**IK10/8**

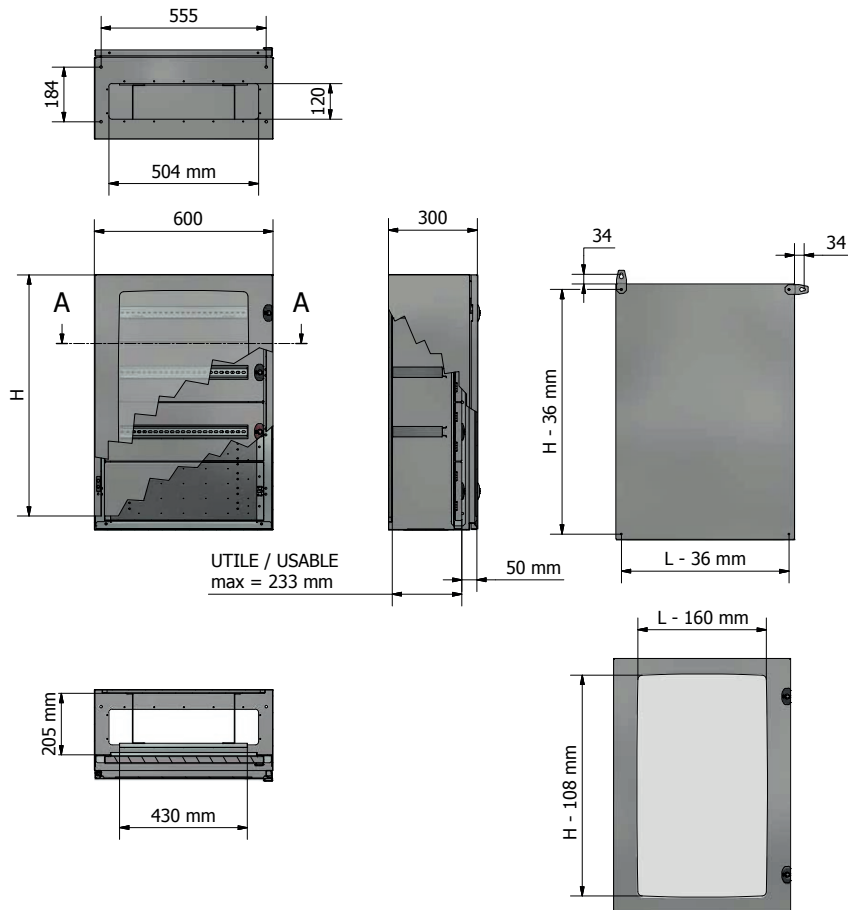

PANNELLI NON INCLUSI  
PANELS NOT INCLUDED



PAG.



SISTEMI DI AERAZIONE  
VENTILATION SYSTEMS

145

Composta da corpo, porta trasparente/cieca, montanti, piastra interna forata e piastrina passacavi.

Composed of cabinet structure, glass door, uprights, punched internal mounting plate and cable entry.



Dimensioni Dimensions		Articolo Article	Versione porta cieca Model door blind	N. serrature No. of hinges	Peso Weight kg	N. pannelli alloggiabili No. of inside panels H=200	Moduli alloggiabili Module slot	
H	H	L	W	P	D			
860	600	300	PDXMT86.60.30	PDXMT86.60.30C	2	28	4	96
1060	600	300	PDXMT106.60.30	PDXMT106.60.30C	2	33	5	120



## ACCESSORI A COMPLEMENTO ACCESSORIES

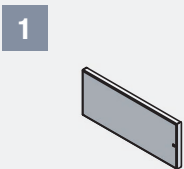

**1** PANNELLO CIECO SINGOLO H=200 INOX  
BLANK SINGLE PANEL H=200 INOX

Dimensioni Dimensions		Articolo Article
H	L	W
200	600	PCX2060

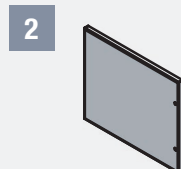

**2** PANNELLO CIECO DOPPIO H=400 INOX  
BLANK DOUBLE PANEL H=400 INOX

Dimensioni Dimensions		Articolo Article
H	L	W
400	600	PCX4060

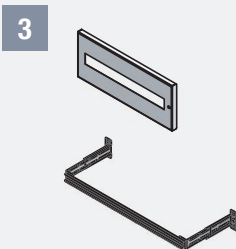

**3** PANNELLO FORATO 24 MODULI H=200  
INOX CON GUIDA DIN E SUPPORTI  
HOLED PANEL H=200 INOX WITH  
24 MODULE SLOTS, ASSEMBLY  
ACCESSORIES AND DIN PROFILE

Dimensioni Dimensions		Articolo Article
H	L	W
200	600	PMX2060



**4** ZOCCOLO INOX H=100  
PLINTH INOX H=100

Dimensioni Dimensions		Articolo Article
L	W	P
600	200	ZX63



### GRIGLIE CON FILTRO IP54

- Griglia in ABS autoestinguente UL94 VO con filtro EU3;
- Viti di fissaggio e guarnizione adesiva;
- Confezione singola in scatola di cartone;
- Colore RAL7035;
- Certificati UL.

### FILTER UNITS IP54

- Grille made of self-extinguishing ABS UL94V0 with EU3 filter;
- Affixed by four self-threading screws;
- Single packet in carton box;
- Painted RAL7035;
- Certified UL.

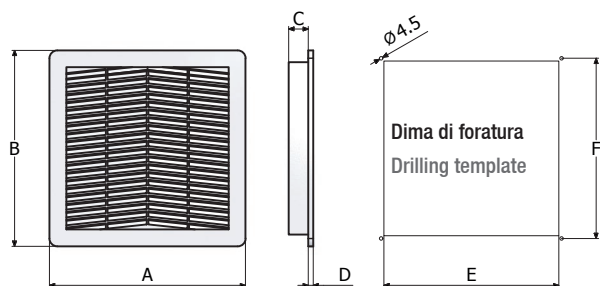

Articolo Article	A	B	C	D	E	F
FIL00	105	105	14	7	92	95
FIL10	150	150	21	7	125	131
FIL20	250	250	23	8	223	230
FIL30	325	325	24	9	291	302



### GRIGLIE CON VENTILATORE IP54

- Griglia in ABS autoestinguente UL94VO con filtro EU4, contenitore ventilatore in ABS con griglia di protezione, ventilatore, morsettiera, guarnizione adesiva e viti di fissaggio;
- Confezione singola in scatola di cartone;
- Colore RAL7035.

### FAN AND FILTER IP54

- Grille made of self-extinguishing ABS UL94V0 with EU4 filter fan with motor protection, gasket, self-threading screws and terminals;
- Single packet in carton box;
- Painted RAL7035.

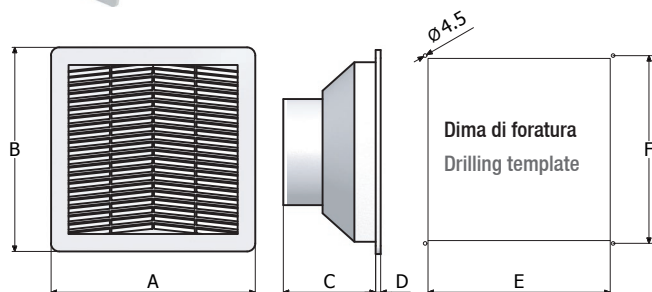

Articolo Article	A	B	C	D	E	F
VEN10 (UL)	150	150	64	7	125	131
VEN20	250	250	113	8	223	230
VEN20UL	250	250	113	8	223	230
VEN30	325	325	152	9	291	302
VEN30UL	325	325	152	9	291	302
VEN910 (UL)	150	150	64	7	125	131
VEN920	250	250	113	8	223	230

Articolo Article	Tensione Power supply	Frequenza Frequency	Assorbimento Absorption	Portata aria kit Air flow set	Rumore Noise	Temp. di esercizio Rated temp. range	
	V	Hz	mA	W	dB (A)	°C	
VEN10 (UL)	230c.a.	50/60	125/110	20/19	57/61	43/48	-10/+55
VEN20 / VEN20UL	230c.a.	50/60	120/120	29/30	240/270	50/55	-10/+55
VEN30 / VEN30UL	230c.a.	50/60	300/370	59/72	520/580	63/65	-10/+55
VEN910 (UL)	115c.a.	50/60	210/180	20/18	57/61	43/48	-10/+55
VEN920	115c.a.	50/60	250/260	29/30	240/270	50/55	-10/+55

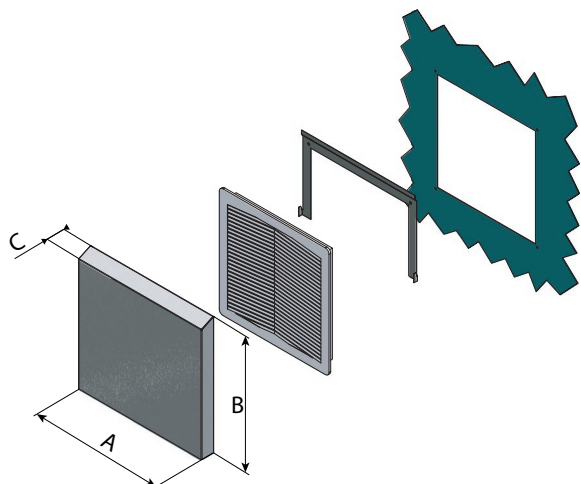

### CUFFIA DI PROTEZIONE INOX

Cuffia inox AISI304 di protezione per filtri e ventilatori.

### STAINLESS STEEL PROTECTION FOR FAN AND FILTER

Protection for fan and filter made in AISI304 stainless steel.

Articolo Article	Compatibili con Compatible with			A	B	C
	FIL	VEN				
RDP10	FIL10	VEN10		188	176	40
RDP20	FIL20	VEN20		288	276	40
RDP30	FIL30	VEN30		367	350	40

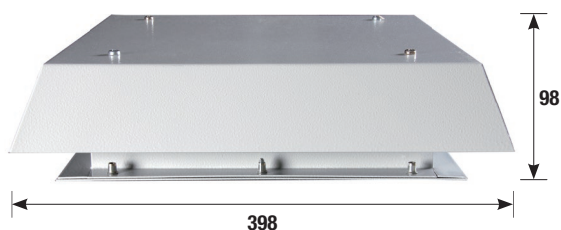

### TORRINO DI ESTRAZIONE MONOFASE

- Grado di protezione: IP 23;
- Composizione: tetto, corpo supporto ventilatore, ventilatore radiale, supporto raccordo di aspirazione con salvadita, condensatore e morsetteria, guarnizione ed accessori per il montaggio;
- Verniciatura: a polveri termoindurenti RAL7035.

### SINGLE PHASE EXTRACTING POWER

- Protection degree: IP 23;
- Composed of: roof, ventilator support, radial ventilator, connector for aspiration with saver finger, terminal and condenser, gasket and mounting accessories;
- Painted: RAL7035.

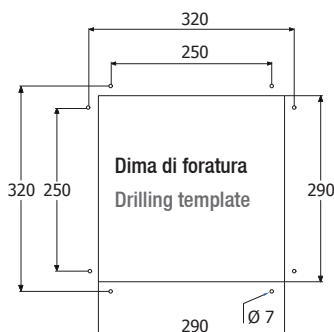

Articolo Article	Alimentazione Voltage	Frequenza Frequency	Assorbimento Absorption		Portata aria Air flow	Rumore Noise	Temp. max Max temp.
	VAC	Hz	A	W	m <sup>3</sup> /h	dB (A)	°C
TV600	220/240	50/60	0,29	65	600	61	60
TV610	115	50/60	0,58	55/69	590/610	58/60	60
TV940	220/240	50/60	0,41	91	940	68	60



### TORRINO DI AERAZIONE

- Grado di protezione: IP 23;
- Verniciatura: a polveri termoindurenti RAL7035.

### AERATION VENTILATOR CHIMNEY

- Protection degree: IP23;
- Painted: RAL7035.

Articolo Article	
TV010	



### TORRINO DI ESTRAZIONE MONOFASE

- Costruzione: struttura in plastica, coperchio inox;
- Verniciatura: RAL7035;
- Grado di protezione: IP54.

### SINGLE PHASE EXTRACTING POWER

- Structure: plastic structure, stainless steel roof;
- Painted: RAL7035;
- Protection degree: IP54.

Articolo Article	Alimentazione Voltage	Frequenza Frequency	Assorbimento Absorption	Portata aria Air flow	Rumore Noise	Temp. max Max temp.
	VAC	Hz	A	W	m <sup>3</sup> /h	dB (A)
TV530	230	50/60	0,71	78/82	530/563	59/61
						°C

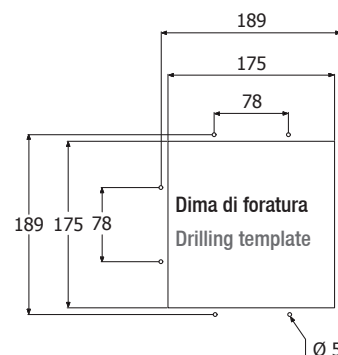

### TORRINO DI AERAZIONE SENZA MOTORE

Grado di protezione: IP 54 verniciatura: a polveri termoindurenti RAL7035.

### AERATION VENTILATOR CHIMNEY WITHOUT ENGINE

Protection degree: IP54 painted: RAL7035.

Articolo  
Article

TV020

### TERMOSTATI

### THERMOSTATS



1

2

3

Articolo  
Article

Descrizione  
Description

1

TE10

10A 230V NC -10° +60°

2

TE20

10A 230V NO -10° +60°

3

TE30

10A 230V NO/NC -10° +65°

### KIT SUPPORTO REGOLABILE PER PROFILO DIN (2+2 PEZZI)

### ADJUSTABLE SUPPORT KIT FOR DIN PROFILE (2+2 PIECES)

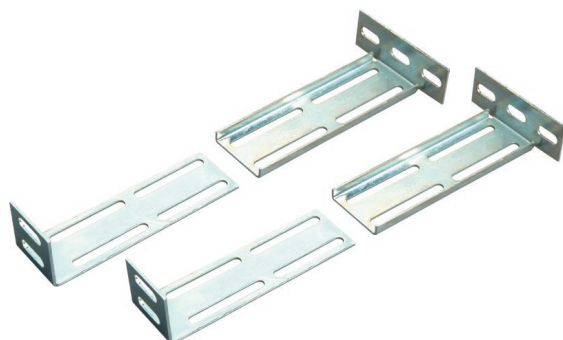

Articolo  
Article

Descrizione  
Description

SU450D

Coppia di supporti profilo DIN H=150 completo di viti  
Couple supports for DIN profile H=150 with bolts